

URBE

User Manual Quick Start Guide

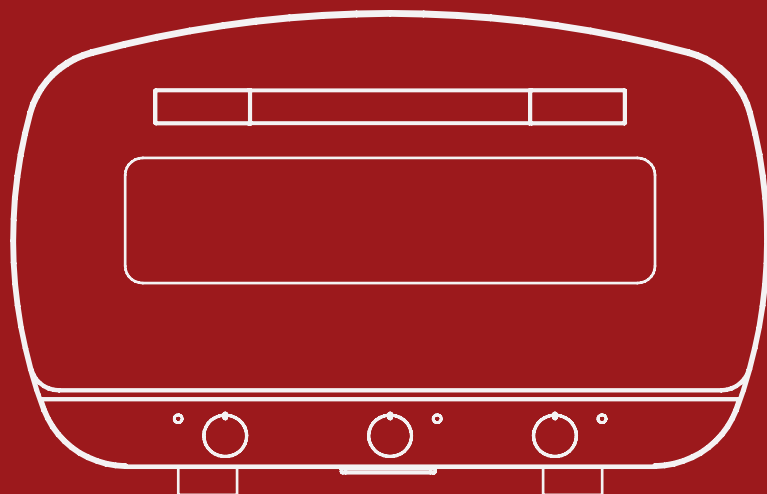

ALFA

www.alfaforni.com

JOIN ALFA

Register your oven product

If you are here, it means that you have purchased an Alfa product and we would like to thank you for this. By choosing our product you are supporting the search and desire to bring good and healthy flame cooking in everybody's life.

Register your purchase and you can download a collection of must-see tips for the best use of your oven.

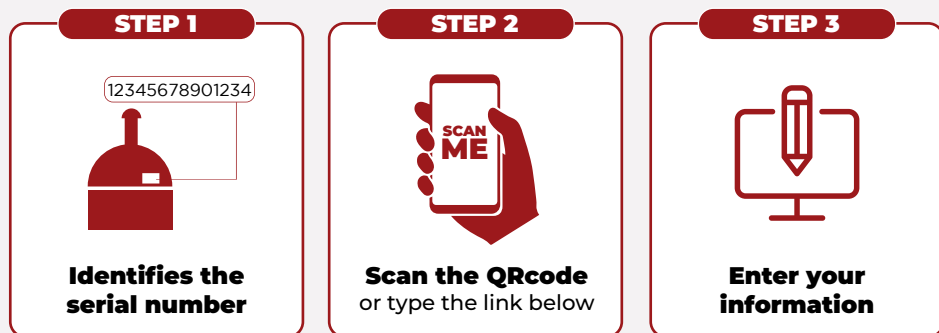

REGISTER YOUR PRODUCT
www.alfaforni.com/registration.php

USER MANUAL

Download the complete user manual



Alfa Forni participates in the SAVE THE PLANET initiative; that's why the manual has been printed only in English. To download the other languages, scan the QR code or click the link below.



Alfa Forni partecipa all'iniziativa SAVE THE PLANET, per questo il manuale è stato stampato esclusivamente in lingua inglese. Per scaricare le altre lingue scansionare il QRcode oppure digitare il link qui sotto.



Alfa Forni nimmt an der SAVE THE PLANET-Initiative teil. Die gedruckte Anleitung ist deswegen nur auf Englisch verfügbar. Um die anderen Sprachen herunterzuladen, scannen Sie den QR-Code oder geben Sie den Link hier unten ein.



Alfa Forni participe à l'initiative SAUVER LA PLANÈTE et pour cela le manuel à été imprimé seulement en anglais. Pour télécharger les autres langues, flashez le code QR ou cliquez sur ce lien.



Alfa Forni participa en la iniciativa SALVAR EL PLANETA, por eso el manual fue publicado solo en inglés. Para descargar los otros idiomas escanea el código QR o haz clic aquí.



DOWNLOAD USER MANUAL
www.alfaforni.com/user-manual-urbe.php

UR3E



ALFA

Index

02	GENERAL WARNINGS
03	PARTS LIST
04	SETTING UP
06	KNOB FUNCTIONS
07	SEASONING AND POWER OFF
08	OVEN DOOR
10	OVEN LIGHT
11	CARE AND MAINTENANCE
12	WARRANTY

GENERAL WARNINGS

PLEASE READ THE FOLLOWING INFORMATION FOR PROPER INSTALLATION AND OPTIMUM PERFORMANCE OF THE OVEN.



- The appliance can be used by children aged 8 years and above, and persons with reduced physical, sensory or mental capabilities or lack of experience and knowledge under supervision, or if they have been given instruction about using the appliance in a safe way and understand the hazards involved. Children shall not play with the appliance. Cleaning and user maintenance shall not be made by children unless they are older than 8 and supervised.
- Keep the appliance and its cord out of reach of children less than 8 years.
- Before turning off the power switch or disconnecting from the outlet, let the oven cool down in standby mode. This will take approximately 20 minutes.
- The appliance is to be connected to a socket-outlet with an earthing contact.
- The supply cord should be regularly examined for signs of damage, and if the cord is damaged, the appliance should not be used. The supply cord must be replaced by the manufacturer, its service agent or similarly qualified persons to avoid a hazard.
- The appliance must be supplied through a residual current device (RCD) having a rated residual operating current not exceeding 30 mA.
- The appliance is not intended to be operated by means of an external timer or separate remote-control system.
- The appliance is intended to be used in household applications only.
- The device can also be used outdoors but must always be protected from any atmospheric agent. Do not store the product outdoors.
- Do not open the door in the event food spontaneously ignites. Any flames will extinguish themselves.
- Do not place oil or baking paper directly on the baking stone.
- Do not use the appliance without the baking stone in place.
- Do not rest anything on the door once open. Avoid cold items of food dropping onto the inside of the door.
- Do not use oven cleaners and metal scourers to clean this appliance.
- Do not use a hose or pressure washer to clean this appliance
- Only store the baking stone inside the oven.
- Do not lean or set items on top of the oven.



THIS APPLIANCE GENERATES HEAT DURING USE. DO NOT TOUCH HOT SURFACES. USE HANDLES OR KNOBS. ALWAYS PROTECT YOUR HANDS WITH NON-SLIP OVEN MITTS OR SIMILAR.

**ALWAYS READ THE COMPLETE USER MANUAL.
Additional copies of the manual on www.alfaforni.com**

PARTS LIST



A >> URBE OVEN

B >> ALFA REFRACTORY BRICK 40x40cm



UPON FIRST USE, THE OVEN MAY EMIT UNPLEASANT ODORS DUE TO THE MATERIALS USED DURING MANUFACTURING. TO REMOVE THE ODOR, HEAT THE EMPTY OVEN AT THE MAXIMUM TEMPERATURE WITH THE DOOR CLOSED. IF POSSIBLE, VENTILATE THE ROOM WHERE THE OVEN IS BEING USED.

THE TILE MAY HAVE ABSORBED MOISTURE DURING TRANSPORT; HEATING THE OVEN ALSO HELPS TO ELIMINATE THIS MOISTURE AND ENSURE OPTIMAL COOKING.

SETTING UP

Step 1:

Take your URBE out of the packaging.



Step 2:

Find a clean, flat, stable surface for your URBE. Clear the space before moving your oven into position.

Remove any flammable objects and materials, including tablecloths.

Think about ventilation when choosing a suitable place for your oven.

Very high cooking temperatures can sometimes cause food to burn, which can produce smoke.



Step 3:

Unwind the power cord. Make sure the central knob is in the zero position before connecting the URBE to a power outlet.

This oven is designed to be used with 230V outlets only.

Caution: The URBE comes with a short power supply cord to reduce the risk of the oven being pulled off the countertop. If you're using an extension cord, make sure that its marked electrical rating is at least as great as the appliance's electrical rating (3100W). Route the extension cord so that it can't be pulled on or tripped over to minimize the risk of the oven falling.



Step 4:

Make sure that the cable doesn't run under the oven or drape over the edge of the countertop or tabletop where it can be pulled on or tripped over.

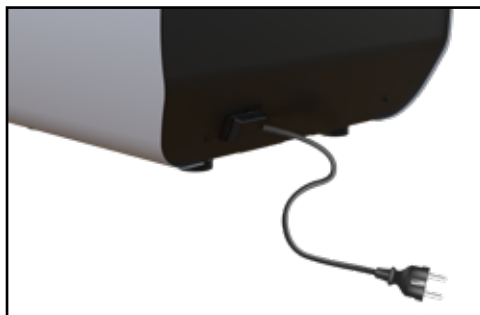

Step 5:

Remove the refractory brick from its packaging and slide it into the URBE.

Attention: when positioning the brick, check that the resistances are correctly positioned in their seats.

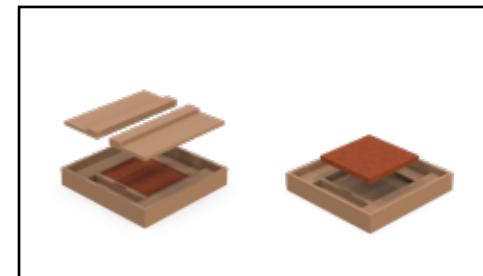

Step 6:

Make sure there is space around the product to allow for safe operation. The area above the oven should be generally clear. Do not place inside an enclosed space.

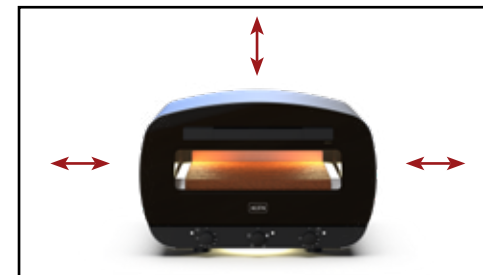

Step 7:

To allow the oven door to open fully, position the oven so the front is close to the edge of your surface.



Step 8:

Check that the 2 temperature control knobs are in the zero position. Turn on the oven by turning the central knob. You will notice that the lights will turn on. The oven will enter standby mode.



Step 9:

Select the cooking mode using the central knob. Then set the temperatures using the 2 side knobs.

See Next Page...

KNOB FUNCTIONS



Floor temperature adjustment knob

Power and function selection knob

Top temperature adjustment knob



C E A

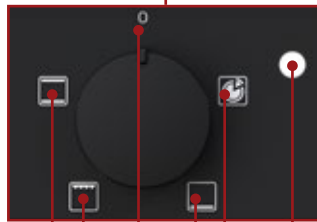

G H A I L B



F A D



A >> ZERO POSITION - OFF

B >> LED ON/OFF URBE OVEN

C >> LED ON/OFF FLOOR AREA

D >> LED ON/OFF TOP AREA

E >> FLOOR AREA SYMBOL

F >> TOP AREA SYMBOL



G >> STATIC FUNCTION

H >> GRILL FUNCTION

I >> FUNCTIONS FLOOR ONLY

L >> PIZZA FUNCTION

The control knob of the URBE oven is analog, so there may be a difference between the indicated temperature and the actual temperature.

SEASONING

Before starting cooking, turn on the oven for 35 minutes to pre-heat it.
To heat the oven:

- turn the central knob to the Pizza function,
- turn both temperature adjustment knobs (floor and top) to 400.

The oven starts heating up immediately.
Keep the door closed during the heating phase.

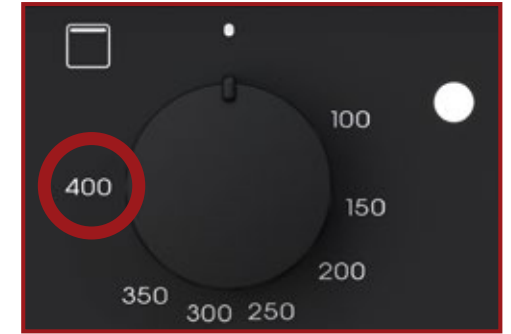

POWER OFF

To turn off the oven, use the central knob and turn it to the zero position.
The oven enters stand-by mode.

WARNING: Before unplugging, allow the oven to cool down in mode standby. It will take approximately 20 minutes.

Before moving the oven, let it cool for 90 minutes.



OVEN DOOR

Removing the "FULL GLASS" panoramic door

WARNING - Make sure that:

- The oven is cool and power to the oven has been turned off before removing the door. Failure to do so could result in electrical shock or burns.
- The oven door is heavy and fragile. Use both hands to remove the oven door. The door front is glass. Handle care-fully to avoid breakage.
- Grasp only the sides of the oven door. Do not grasp the handle as it may swing in your hand and cause damage or injury.
- Failure to grasp the oven door firmly and properly could result in personal injury or product damage.

Removing the oven door

The oven door can be removed quickly and easily.

To do so, proceed as follows:

- Open the door fully.
- Lift the two levers shown below.
- Close the door as far as the first stop (caused by the raised levers).
- Lift the door upwards and outwards to remove it from its mountings.

To replace fit the door, fit the hinges in their mountings and lower the two levers

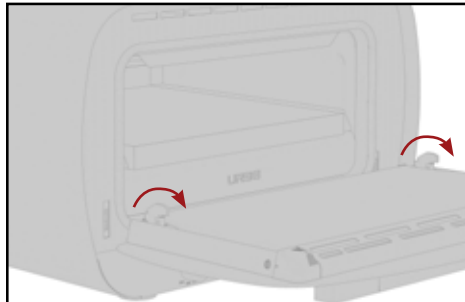
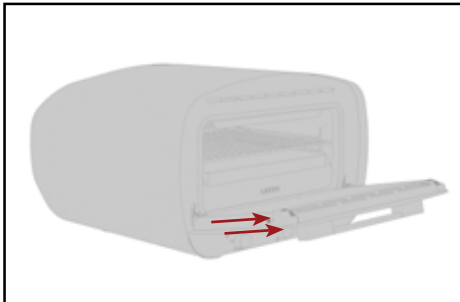

How to remove the inner glass of the "FULL GLASS" panoramic door

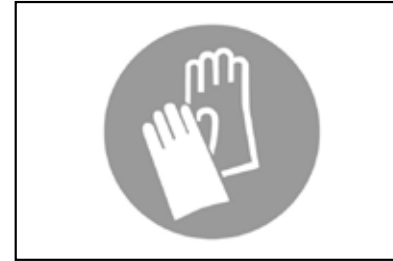

Step 1:
Wear protective gloves.

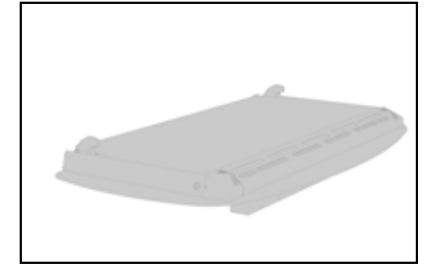

Step 2:
Place the door on a flat horizontal surface face down on a soft cloth to avoid scratching the visible part.

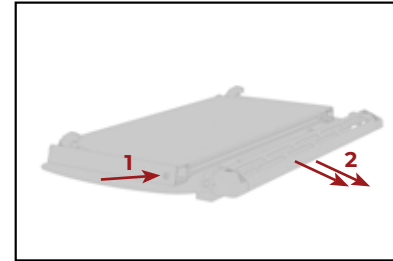

Step 3:
Remove the two lateral caps and pull out the top strip.

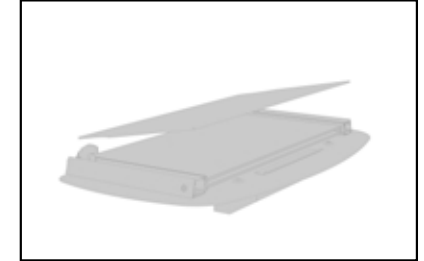

Step 4:
Slide out the internal glass as shown below. Pull out the second and third glass panels (intermediate panels) to clean them.

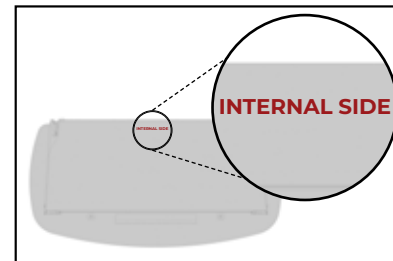

Step 5:
Replace the middle panes after cleaning in reverse order, checking that they are oriented so the words INTERNAL SIDE are properly legible.



Step 6:
Place the inner glass between the two uprights and put the upper strip back in place.

NOTE: a slight gap between the middle panes and the side supports is normal because it allows for the heat expansion of the glass.

REPLACEMENT OF THE OVEN LIGHT

WARNING - Make sure that:

- The oven and lights are cool and power to the oven has been turned off before replacing the light bulb(s). Failure to do so could result in electrical shock or burns.
- The lenses must be in place when using the oven.
- The lenses serve to protect the light bulb from breaking.
- The lenses are made of glass. Handle carefully to avoid breakage. Broken glass could cause an injury.

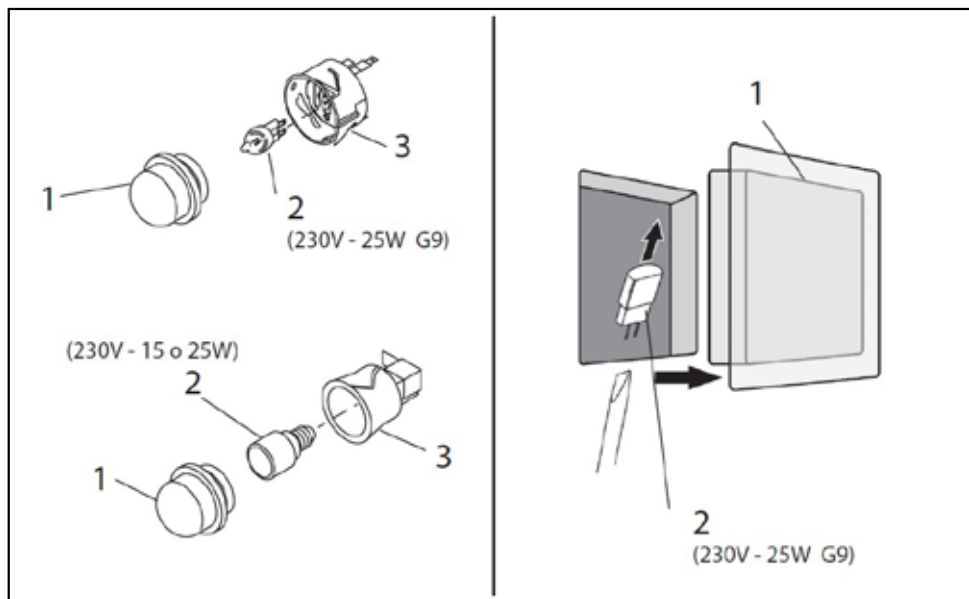

1. Turn off power at the main power supply (fuse or breaker box).
2. Remove the lens (1).
3. Remove the light bulb (2) from its socket (3).
4. Replace the bulb (2) with a new one. Avoid touching the bulb with fingers, as oils from hands can damage the bulb when it becomes hot.
5. Use one with the same Volt and Watt (see figure).
6. Screw the lens (1) back on.
7. Turn power back on at the main power supply (fuse or breaker box).

CARE AND MAINTENANCE

Storing

- You can use URBE outside. Store indoors in dry conditions when not in use.
- Only store the baking stone inside the oven, don't store food or other items in the oven cavity.
- Do not lean on or put items on top of your URBE. Doing so could damage your oven.

Refractory Brick

1. DO NOT use the baking stone over an open flame.
2. Avoid extreme temperature change to the stone. DO NOT place frozen foods onto the stone if using temperatures in excess of 200°C.
3. The stone is fragile and can break if bumped or dropped.
4. The stone is very hot during use and stays hot for a long time after use.
5. DO NOT cool the stone with water or use it when damp.
6. To clean off burned food marks, wait until the stone is cool, use two hands to carefully take it out of the oven, flip it over and slide it gently back in. The debris on the underside of the stone will burn away the next time you use your URBE.
7. If your stone breaks: Turn your oven off, let it cool and unplug it before you remove the broken baking stone. If your URBE is in warranty, get in touch with our support team to order a replacement.

Oven Interior and Exterior

Your URBE should not require any interior cleaning. Any food residue should burn off when in use. You can use a wire brush to sweep away excess debris on the stone.

Don't use oven cleaners or metal scourers to clean your pizza oven because they will damage the URBE.

To clean the outside of your pizza oven, wait until it's cool, unplug it and use a lightly damp cloth to wipe the oven body. Dry with a clean towel right away.

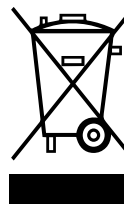

DISPOSAL OF USED EQUIPMENT

At the end of the period of use, it is forbidden to dispose of these household appliances with normal municipal waste; rather, they must be delivered to the collection and recycling point for electrical and electronic equipment; as highlighted by the symbol in the instruction manual or on the packaging.

Information relating to the disposal points of unusable appliances will be provided to you by the competent territorial authorities.

WARRANTY



ALFA ovens are covered by a 24-month warranty relating to conformity defects. Correct maintenance and proper use of the product will help extend its working life.

For country specific legal warranty regulations, please refer to what is stated in the individual national reference provisions.

NOTE

PLEASE RETAIN YOUR PURCHASE RECEIPT OR INVOICE TO SHOW TO YOUR DEALER. WE SUGGEST YOU NOTE DOWN BELOW THE OVEN SERIAL NUMBER INDICATED ON THE IDENTIFICATION LABEL LOCATED ON THE BACK OF THE PRODUCT.

Please contact your dealer in case of any warranty claims.

The warranty does not cover:

Transport damage, in the event of such damage, it should be immediately noted on the transport document by affixing, upon receipt of the product, the words "acceptance with reservation" and immediately contacting the dealer for further clarification;

Improper use of the oven and installation differing from that described in this manual.

Any tampering with the oven, either intentionally or unintentionally or alterations to the condition the oven was in when delivered;

Cases of failure to follow the instructions relating to proper maintenance and product cleaning as indicated in the manual;

Cases of the use of components not manufactured or recommended by Alfa;

Damage caused by the use of chemicals inside or outside the oven;

The label located on the back of the product having been removed, altered or erased;

Cases of normal wear and tear of the product due to use by the consumer;

Small surface imperfections present on painted or aesthetic parts that do not affect the normal use of the product;

Accessory parts of the product such as door and glass;

The refractory stone is not covered by warranty.

In the case of non-domestic use of the product;

Removable parts, knobs, handles, flame spreaders, grills, lamps, glass and enamelled parts, rubber and plastic parts, external pipes, gaskets, materials subject to wear and any accessories and consumables unless it is demonstrated that there is a manufacturing defect;

Any damage due to overvoltage or the use of current with inadequate power and/or voltages;

The Manufacturer declines all responsibility for any damage that may, directly or indirectly, arise to people, things or animals, as a result of failure to comply with all the provisions indicated in this manual and especially concerning those regarding installation, use and maintenance of the household appliance.

We recommend the exclusive use of ALFA branded spare parts

JOIN ALFA

Register your oven product

If you are here, it means that you have purchased an Alfa product and we would like to thank you for this. By choosing our product you are supporting the search and desire to bring good and healthy flame cooking in everybody's life.

Register your purchase and you can download a collection of must-see tips for the best use of your oven.

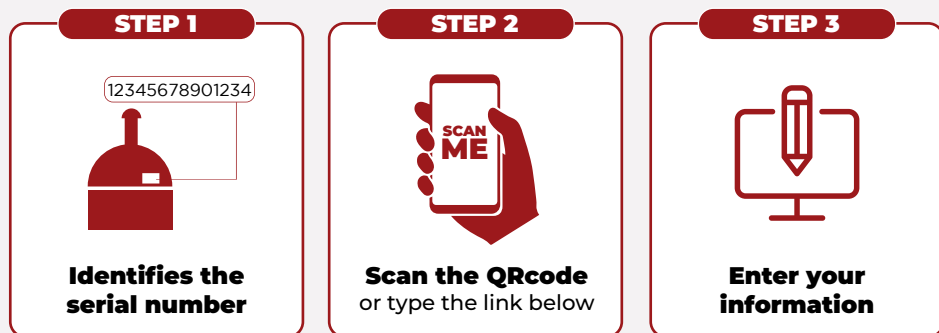

REGISTER YOUR PRODUCT
www.alfaforni.com/registration.php

USER MANUAL

Download the complete user manual



Alfa Forni participates in the SAVE THE PLANET initiative; that's why the manual has been printed only in English. To download the other languages, scan the QR code or click the link below.



Alfa Forni partecipa all'iniziativa SAVE THE PLANET, per questo il manuale è stato stampato esclusivamente in lingua inglese. Per scaricare le altre lingue scansionare il QRcode oppure digitare il link qui sotto.



Alfa Forni nimmt an der SAVE THE PLANET-Initiative teil. Die gedruckte Anleitung ist deswegen nur auf Englisch verfügbar. Um die anderen Sprachen herunterzuladen, scannen Sie den QR-Code oder geben Sie den Link hier unten ein.



Alfa Forni participe à l'initiative SAUVER LA PLANÈTE et pour cela le manuel à été imprimé seulement en anglais. Pour télécharger les autres langues, flashez le code QR ou cliquez sur ce lien.



Alfa Forni participa en la iniciativa SALVAR EL PLANETA, por eso el manual fue publicado solo en inglés. Para descargar los otros idiomas escanea el código QR o haz clic aquí.



DOWNLOAD USER MANUAL
www.alfaforni.com/user-manual-urbe.php

URBE